

Specifications for Approval

Customer Part No.:

Inhere Part No.: LUG935A3-001

Part Name: 平头小蝴蝶水清透明翠绿光 LED

Spec Issue Date: 2018-08-13

Revision No.: A

To Customer:

We submit herewith the following information for your approval:

- Sample OQC Inspection Record LED Dimension
 Electrical Characteristics Curve Internal Circuit Diagram
 Soldering recommendation

Prepared by: Lily
Date: 2018-08-13

Checked by: Tom
Date: 2018-08-13

Approved by: Wangxiaojun
Date: 2018-08-13

Customer Opinion

- Approve and no objection
 Reject with the following reason:

inhere 
light for your mind
银河光电

东莞市银河光电有限公司
DongGuan Inhere Opto CO.,LTD.
地址:东莞市莞城科技园 D 幢
ADD:Guancheng Science & Technology Park, DongGuan
TEL: 0769-23320868 FAX: 0769-23320878
E-mail: bill@inhereopto.com
Http://www.inhereopto.com

SPECIFICATIONS

Features

- High speed response.
- High reliability and long life.
- Low power consumption.
- Available in red, orange, yellow, yellow-green, green, blue, white, pink*
- Suitable for pulse operation.
- RoHS compliant.

Description

- The Green source color devices are made with InGaN/GaN on Al₂O₃ Light Emitting Diode.

Applications

- Automotive: Dashboards, stop lamps,
- Backlighting: LCDs, Key pads advertising
- Status indicators: Consumer & industrial electronics.
- General use

Dimensions

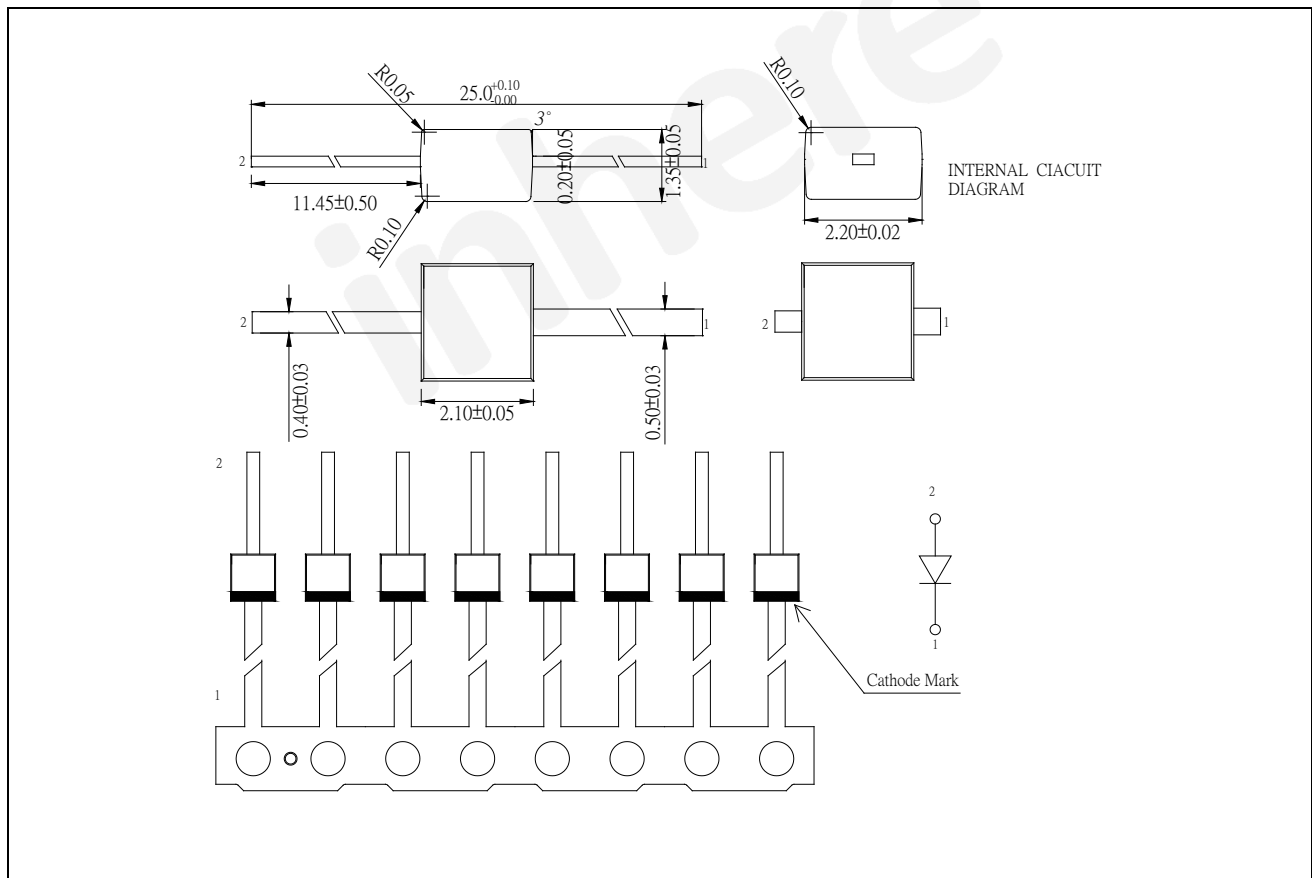

Notes:

1. All dimensions are in millimeters (inches).
2. Tolerance is ± 0.25 (0.01") unless otherwise noted.
3. Lead spacing is measured where the leads emerge from the package.
4. Specifications are subject to change without notice.

Selection Guide

Part No.	Dice	Emitting Color	Lens Type	I _v (mcd) @ 20mA			Viewing Angle(°)
				Min.	Typ.	Max	2θ _{1/2}
LUG935A3-001	InGaN	Green	Water Clear	260	530	--	120

Note:

1. θ_{1/2} is the angle from optical centerline where the luminous intensity is $\frac{1}{2}$ the optical centerline value.
2. The tolerance of luminous intensity (I_v) is ±15%.

Electrical / Optical Characteristics (at T_a = 25°C)

Parameter	Symbol	Value			Unit	Test Condition
		Min.	Typ.	Max.		
Forward Voltage	V _F	2.6	--	3.4	V	I _F = 20mA
Dominant Wavelength	λ _D	510	--	525	nm	I _F = 20mA
Reverse Current	I _R	--	--	10	μA	V _R = 5V
Spectral Line Half Width	Δλ	--	35	--	nm	I _F = 20mA

Note:

1. The tolerance of forward voltage is ±0.05V.
2. The tolerance of dominant wavelength is ±1nm.
3. This specification is a standard specification of our factory, can make in accordance with customer's special requirement.

Absolute Maximum Ratings (at T_a = 25°C)

Parameter	Symbol	Value	Unit
Power Dissipation	P _D	95	mW
Peak Forward Current * 1	I _{FP}	100	mA
Forward Current	I _F	25	mA DC
Reverse Voltage	V _R	5	V DC
Operating Temperature	T _{opr}	-40 ~ +85	°C
Storage Temperature	T _{stg}	-40 ~ +100	°C
Soldering Temperature	T _{sol}	260°C for 5 sec 3 times	

* 1 Condition for I_{FP} is pulse of 1/10 duty and 0.1msec width.

Reliability Testing Conditions

Classification	Test Item	Reference Standard	Test Conditions	Result
Endurance Test	Operation Life	MIL-STD-750D:1026 MIL-STD-883D:1005 JIS-C-7021:B-1	Ta: Under room temperature Test time:1,000hrs IF= Product Recommended IF	0/32
	High Temperature High Humidity Storage	MIL-STD-202F:103B JIS-C-7021:B-11	Ta:85±5℃ RH:90%-95% Test time:240hrs	0/32
	High Temperature Storage	MIL-STD-883:1008 JIS-C-7021:B-10	Ta:100±5℃ Test time:1,000hrs	0/32
	Low Temperature Storage	JIS-C-7021:B-11	Ta:-40±5℃ Test time:1,000hrs	0/32
Environmental Test	Temperature Cycling	MIL-STD-202F:107D MIL-STD-750D:1051 MIL-STD-883D:1010 JIS-C-7021:A-2	Ta: -40℃±5℃~25℃±5℃~100℃±5℃~25℃±5℃ 30min 5min 30min 5min	0/32
	Thermal Chock	MIL-STD-202F:107D(1980) MIL-STD-750D:1051(95) MIL-STD-883D:1011(1991)	Ta: -40℃±5℃~85℃±5℃ 10min 10min Time:20min/cycle 10cycle	0/32
	Wetting balance	MIL-STD-883:2003 MIL-STD-202F:208D MIL-STD-883D:2003	Ta: 230℃±5℃ Time:5±0.5s	0/32
	Solder Resistance	MIL-STD-202F:210A MIL-STD-883D:1011 JIS-C-7021:A-1	Ta: 260℃±10℃ Time:10±1s	0/32

Characteristic Curves

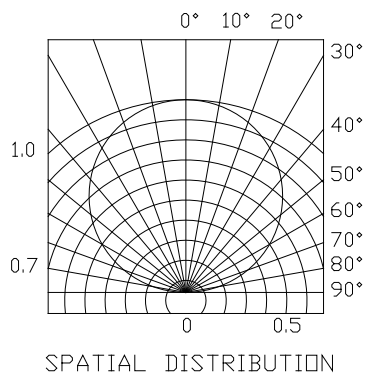
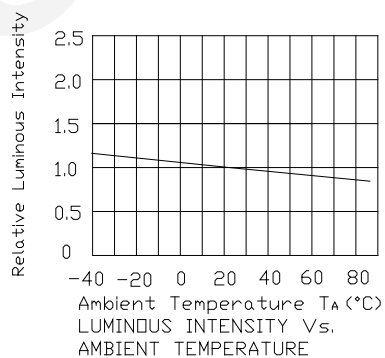
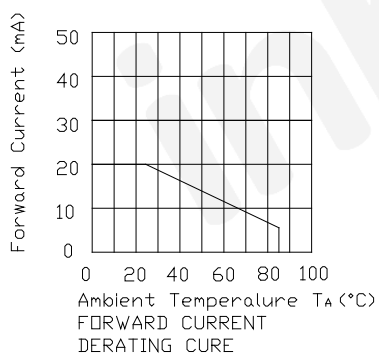
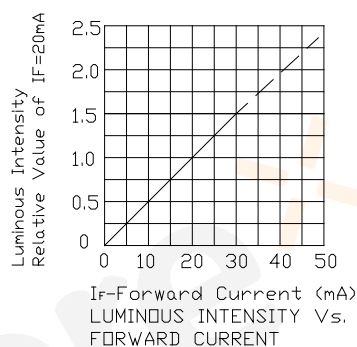
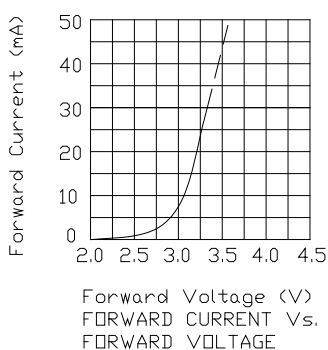
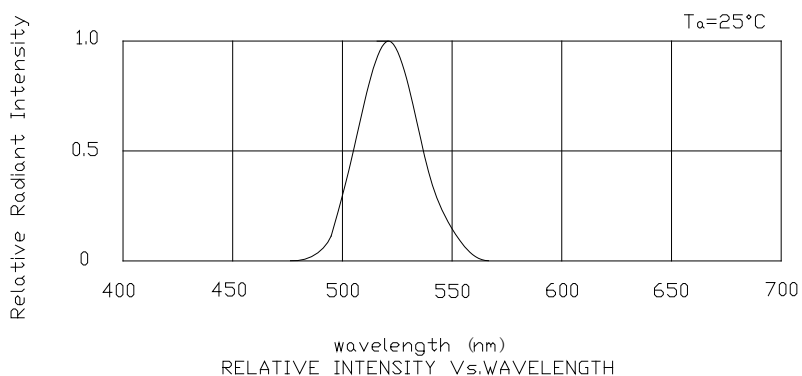

IR-Reflow Soldering

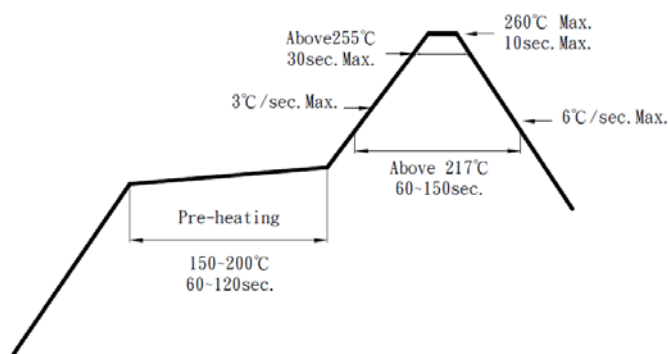

1. Avoid any external stress applied to the resin while the LEDs are at high temperature, especially during soldering.
2. Avoid rapid cooling or any excess vibration during temperature ramp-down process
3. Although the soldering condition is recommended above, soldering at the lowest possible temperature is feasible for the LEDs

IRON Soldering

350°C Within 3 sec., One time only.

Notes for designing:

Care must be taken to provide the current limiting resistor in the circuit so as to drive the Inhere LEDs within the rated figures. Also, caution should be taken not to overload Inhere LEDs with instantaneous voltage at the turning ON and OFF of the circuit.

When using the pulse drive care must be taken to keep the average current within the rated figures. Also, the circuit should be designed so as to be subjected to reverse voltage when turning off the Inhere LEDs.

Storage:

In order to avoid the absorption of moisture, it is recommended to solder Inhere LEDs as soon as possible after unpacking the sealed envelope.

If the envelope is still packed, to store it in the environment as following:

(1) Temperature: 5°C-30°C; Humidity: RH 60%Max.

(2) After this bag is opened, devices that will be applied to infrared reflow, vapor-phase reflow, or equivalent soldering process must be:

a. Completed within 168 hours.

b. Stored at less than 30% RH.

(3) Devices require baking before mounting, if:

(2) a or (2) b is not met.

(4) If baking is required, devices must be baked under below conditions:

48 hours at 60°C±3°C.