

Specifications for Approval

Customer Part No.:

Inhere Part No.: LUG50343-001

Part Name: 5mm 圆头有边水清透明翠绿光 LED

Spec Issue Date: 2018-07-16

Revision No.: A

=====

To Customer:

We submit herewith the following information for your approval:

- Sample OQC Inspection Record LED Dimension
 Electrical Characteristics Curve Internal Circuit Diagram
 Soldering recommendation

Prepared by: Lily
Date: 2018-07-16

Checked by: Tom
Date: 2018-07-16

Approved by: Wangxiaojun
Date: 2018-07-16

=====

Customer Opinion

- Approve and no objection
 Reject with the following reason:

inhere 
light for your mind
银河光电

东莞市银河光电有限公司
DongGuan Inhere Opto CO.,LTD.
地址:东莞市莞城科技园 D 幢
ADD:Guancheng Science & Technology Park, DongGuan
TEL: 0769-23320868 FAX: 0769-23320878
E-mail: bill@inhereopto.com
Http://www.inhereopto.com

SPECIFICATIONS

Features

- High speed response.
- High reliability and long life.
- Low power consumption.
- Available in red, orange, yellow, yellow-green, green, blue, white, pink*
- Suitable for pulse operation.
- RoHS compliant.

Description

- The Green source color devices are made with InGaN/GaN on Al₂O₃ Light Emitting Diode.

Applications

- Consumer electronics
- Display boards
- Indicators

Dimensions

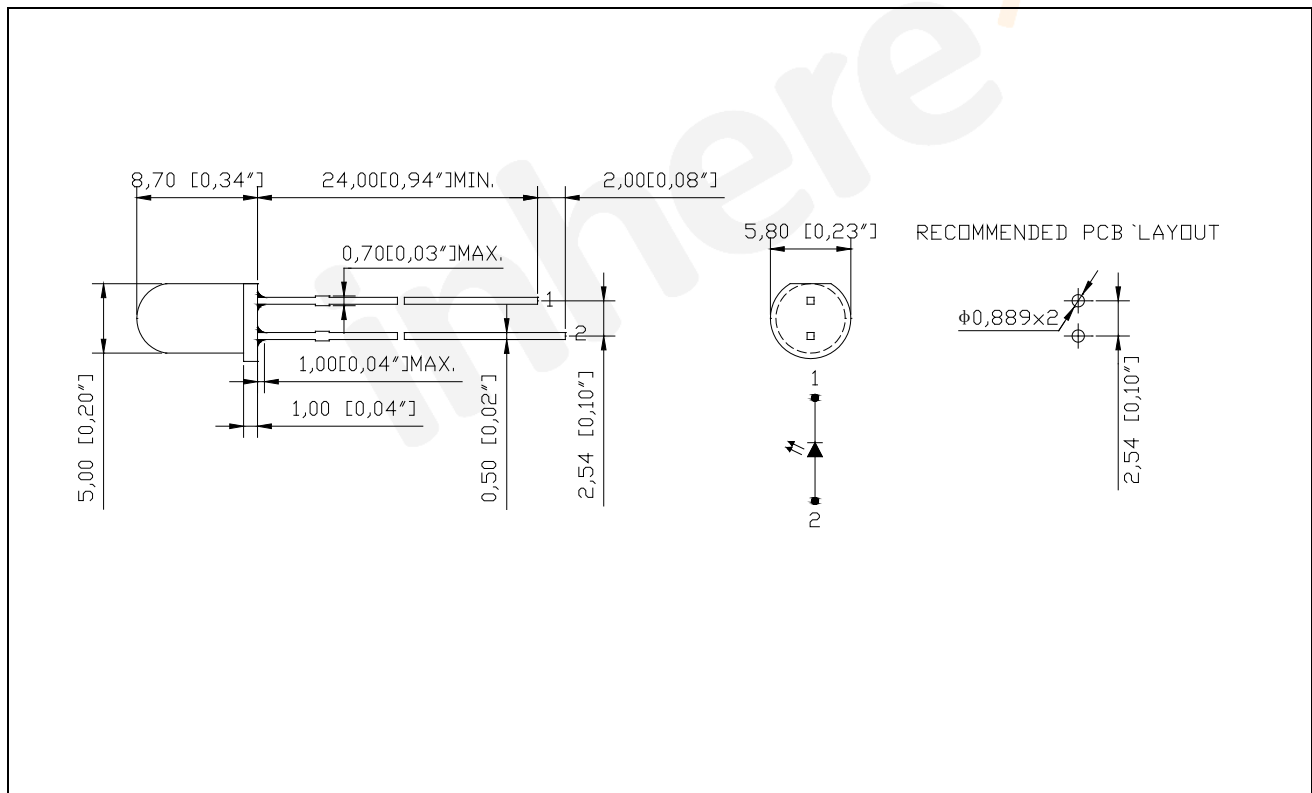

Notes:

1. All dimensions are in millimeters (inches).
2. Tolerance is ± 0.25 (0.01") unless otherwise noted.
3. Lead spacing is measured where the leads emerge from the package.
4. Specifications are subject to change without notice.

Selection Guide

Part No.	Dice	Lens Type	I _v (mcd) @ 20mA		Viewing Angle(°)
			Min.	Typ.	2θ _{1/2}
LUG50343-001	InGaN/GaN	Water Clear	10000	25000	15

Note:

1. 2θ_{1/2} is the angle from optical centerline where the luminous intensity is $\frac{1}{2}$ the optical centerline value.
2. The tolerance of luminous intensity (I_v) is ±15%.

Electrical / Optical Characteristics (at T_a = 25°C)

Parameter	Symbol	Value			Unit	Test Condition
		Min.	Typ.	Max.		
Forward Voltage	V _F	2.8	--	3.6	V	I _F = 20mA
Dominant Wavelength	λ _D	515	--	525	nm	I _F = 20mA
Reverse Current	I _R	--	--	10	μA	V _R = 5V

Note:

1. The tolerance of forward voltage is ±0.05V.
2. The tolerance of dominant wavelength is ±1nm.
3. This specification is a standard specification of our factory, can make in accordance with customer's special requirement.

Absolute Maximum Ratings (at T_a = 25°C)

Parameter	Symbol	Value	Unit
Power Dissipation	P _D	108	mW
Pulse Forward Current(Duty 1/10 @ 1 kHz)	I _{FP}	100	mA
Forward Current	I _F	30	mA DC
Reverse Voltage	V _R	5	V DC
Operating Temperature	T _{opr}	-40 ~ +85	°C
Storage Temperature	T _{stg}	-40 ~ +85	°C
Soldering Temperature	T _{sol}	260°C for 5 sec	

Reliability Testing Conditions

NO	Test Item	Test Conditions	Duration	Sample	Ac/Re
1	Temperature Cycle	-40°C ± 5°C ~ 25°C ± 5°C ~ 100°C ± 5°C ~ 25°C ± 5°C 30min 5min 30min 5min	100 cycles	22	0/1
2	High Temperature Storage	T _a =100°C ± 5°C	1000 hours	22	0/1
3	Temperature & Humidity Test	T _a =85°C ± 5°C RH=85% ± 5%	1000 hours	22	0/1
4	Low Temperature Storage	T _a =-40°C ± 5°C	1000 hours	22	0/1
5	Operating Life Test	T _a =25 ± 5°C DC IF=20mA	1000 hours	22	0/1
6	Solder Heat	T _{sol} =260±5°C, 5s	1 times	22	0/1
7	Thermal Shock	-40±5°C → 100±5°C 15min 15min	100 cycles	22	0/1

Optical Characteristic Curves

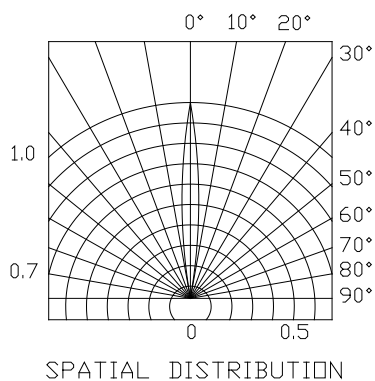
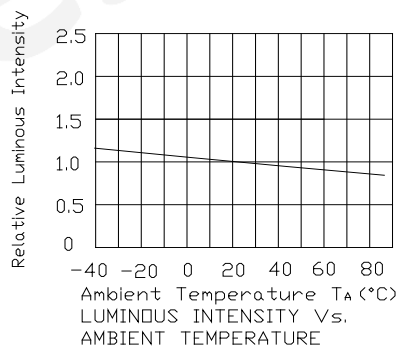
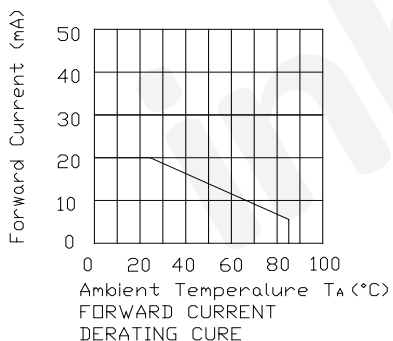
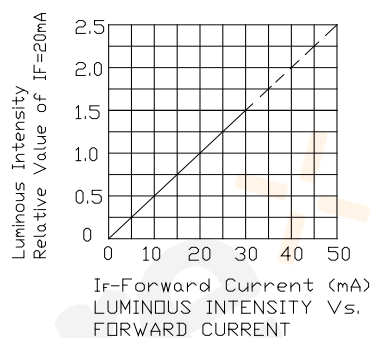
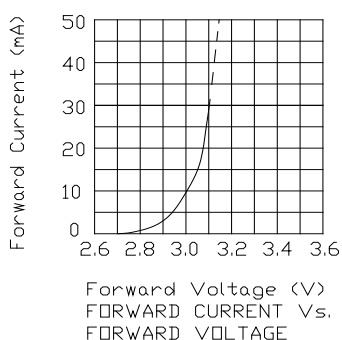
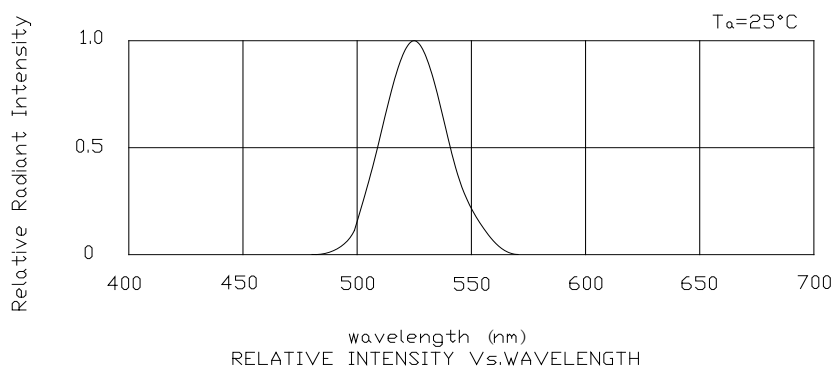

Precautions in Use

1. Soldering Condition

- a. When soldering, leave the minimum clearance between the bottom of the resin and the soldering point.
- b. Do not solder closer than 3mm from the base of the epoxy bulb.
- c. Maximum allowance soldering conditions are:
Dip Soldering: 260°C max., 5 sec Max., 1 time.
Soldering iron: 350°C max., 5 sec Max., 1 time
- d. Contact between molten solder and the resin shall be avoided.
- e. During soldering, do not put any stress on the lead frame, particularly when heated.

2. Lead frame Forming and Use

- a. When forming leads, the leads shall be bent at a point at least 3mm from the base of epoxy bulb. Do not use the base of the lead frame as a fulcrum during lead forming.
- b. Lead forming shall be done before soldering.
- c. Do not apply any bending stress to the base of the lead. The stress to the base may damage the LED's characteristics or it may break the LED.
- d. When mounting the LED onto a printed circuit board, the holes on the PCB shall be exactly aligned with the leads of the LED. If the LED is mounted with stress at the leads, it may cause deterioration of the epoxy resin and this may degrade the LED.
- e. Avoid condition which may cause the LED to corrode, tarnish or discolor. This corrosion or discoloration may cause difficulty during soldering operation. It is recommended that the LED be used as soon as possible.
- f. Avoid rapid transition in ambient temperature, especially in high humidity environment.

3. Static Electricity

- a. The product is sensitive to static electricity charge, and user is required to handle it with care. Particularly, if a current and/or voltage which exceed the Absolute Maximum Rating of the Product is applied, the overflow in energy may cause damage to, or possibly result in electrical destruction of, the LED. The customer is requested to take adequate countermeasure against static electricity charge and surge when handling it.
- b. Proper grounding, use of conductive mat, conductive working uniform and shoes, and conductive containers are effective against static electricity and surge.
- c. Ground low-resistance area where the product contacts, such as metal surface of the work platform, with a conductive mat (surface resistance $10^6 \sim 10^9$ ohm).
- d. A tip of soldering iron is requested to be grounded. An ionizer shall also be installed where risk of static generation is high.

Notes:

1. The above specification and dimensions may be modified for product improvement. Inhere reserves the right to change the specification without notice.
2. When using this product, please observe the Absolute Maximum Ratings and the instructions in the specification sheets. Inhere assumes no responsibility for any damage resulting from use of the product that does not comply with the instructions.